

Project: _____ TYPE: _____

Product Features

- Designed for architectural facade, bridge, and media display applications
- Low power consumption with efficient power management design
- Standard DMX 512 control protocol (Max. 44 frames/second)
- Amazing resolution with 3 pixels per foot
- Perfect light synchronization with Artnet system and ESD protection
- Electrical protection for short circuit, over current, over voltage, and over temperature
- Dynamic resolution control ranging from the entire fixture length down to 4" segments
- IP67 rated
- Mounting brackets included (2 per fixture)
- 3G Vibration Rated

Dimensions

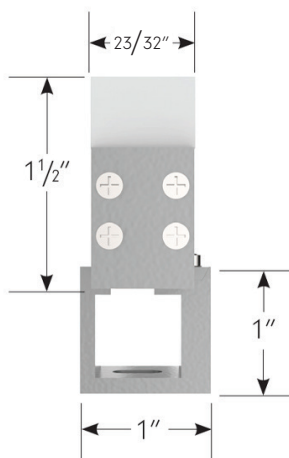

Order Specification Guide

PRODUCT CODE	LENGTH	PIXEL/FOOT	VOLTAGE
MLB	-	3	-
MLB = Magic Linear Bar	1 = 1ft 2 = 2ft 3 = 3ft 4 = 4ft	3 = 3 pixels per ft.	24 = 24V DC

Note: A layout/drawing must accompany each order showing run length and location

Specifications

Output	
LED Channels	Red / Green / Blue / White (4000K)
Lumens (lm/ft)	106 (all colors fully on)
Efficacy (lm/W)	78
Beam Angle	145° x 105°
On-Axis Candela	44
Pixels	3 pixels/ft
Electrical	
Input Voltage	24V DC
Power Consumption (W/ft)	3
Maximum Run	32'
Control	
Control System	DMX 512 / Artnet
Address Setting	Auto / Manual
Physical	
Dimensions W/ Bracket	1.12" W x 2.48" D x 39.37" L
Dimensions W/O Bracket	0.71" W x 1.5" D x 39.37" L
Housing	Aluminum Powder Coat - Gray
Housing Expansion/Contraction	0.5cm (0.2")
Lens	Opal PMMA Acrylic
Mounting	Surface Mount
Cooling	Passive
Cable Entry	Bottom
Operating Temperature	-20°C to 50°C (-4°F to 122°F)
Storage Temperature	-40°C to 80°C (-40°F to 176°F)
Certification and Testing	
Certification	cETLus, CE, RoHS
Environment	Wet Location
IP Rating	IP67
Vibration	3G (ANSI C136.31)

Photometrics

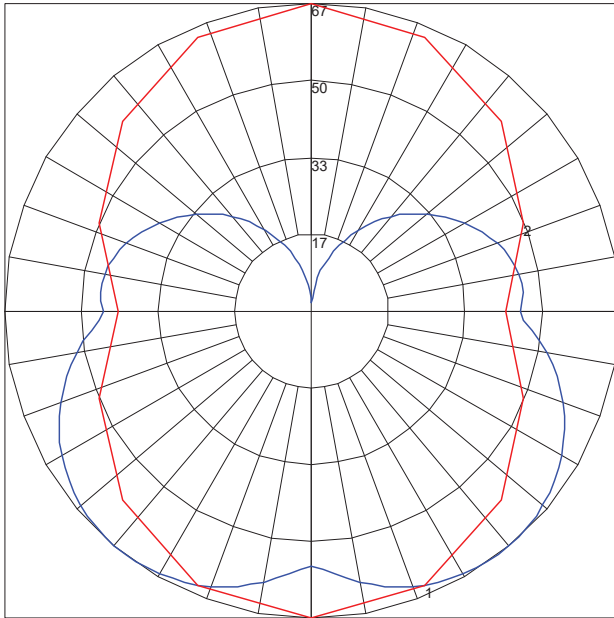

Maximum Candela = 66.5
 Located At Horizontal Angle = 90
 Vertical Angle = 37.5
 #1 Vertical Plane Through Horizontal Angles (90-270) (Through Max. Cd.)
 #2 Vertical Cone Through Vertical Angle (37.5) (Through Max. Cd.)

TM-30

Hue Bin	R_f	Graphic Shifts (%)	
		Chroma	Hue
1	65	15%	5%
2	71	14%	-8%
3	58	7%	-21%
4	62	-8%	-20%
5	68	-17%	-10%
6	83	-6%	7%
7	75	1%	14%
8	69	9%	15%
9	77	14%	11%
10	78	10%	-2%
11	74	8%	-10%
12	74	-1%	-16%
13	80	-7%	-8%
14	75	-8%	11%
15	72	8%	11%
16	72	9%	12%

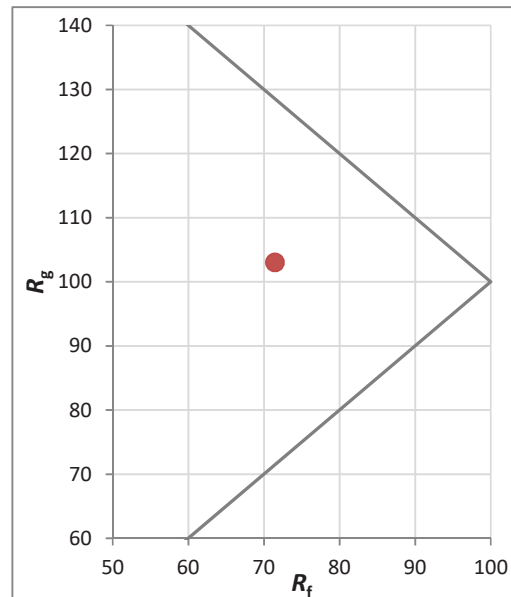

TM-30

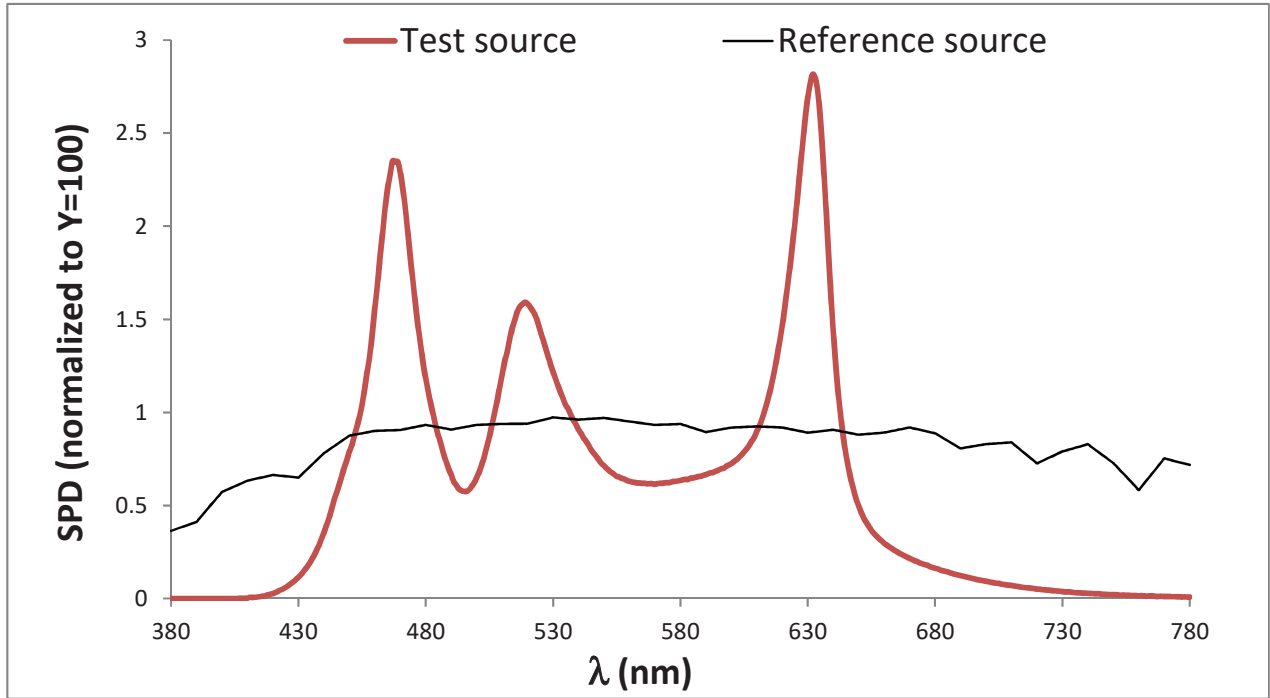

Color Vector Graphic

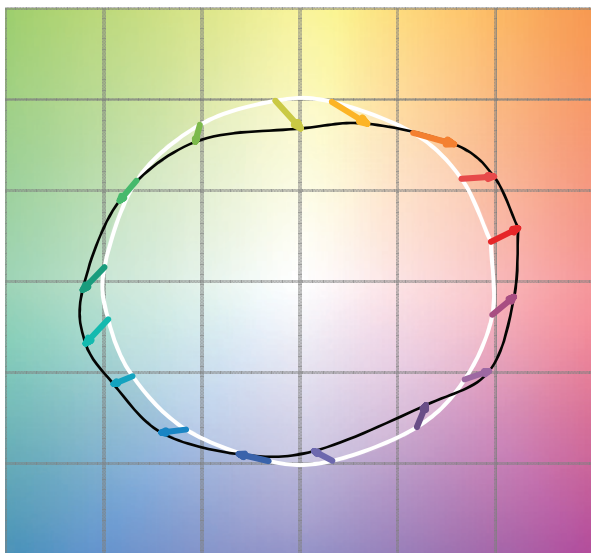

Color Distortion Graphic

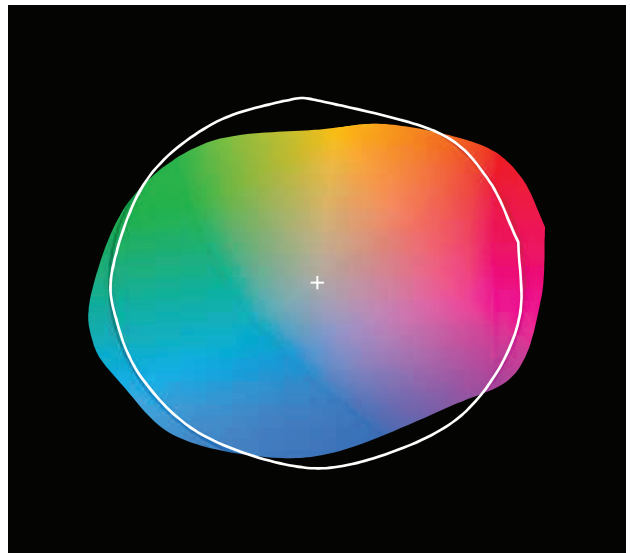

TM-30

Hue Angle Bin vs. Fidelity Index

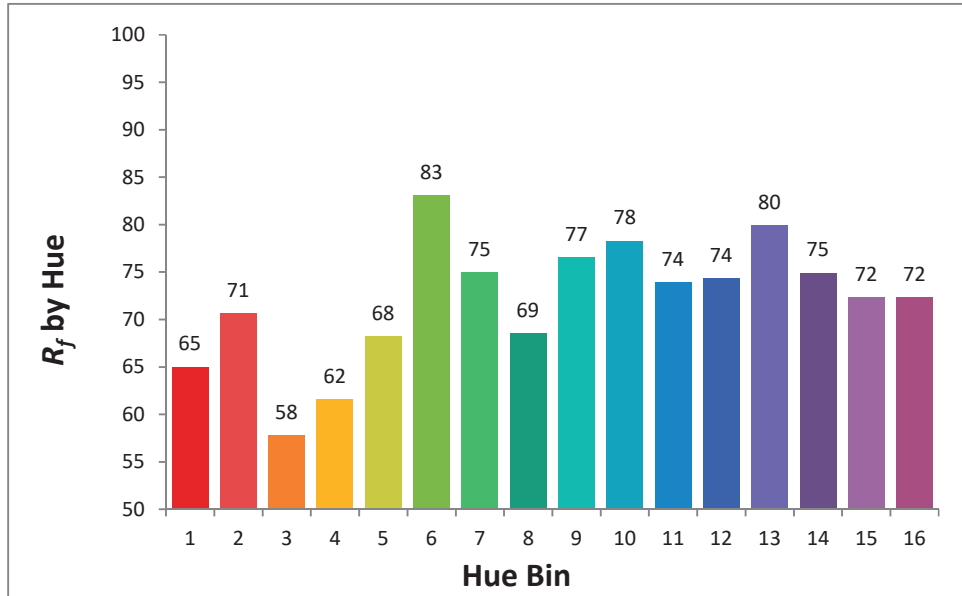

Hue Angle Bin vs. Change of Chroma

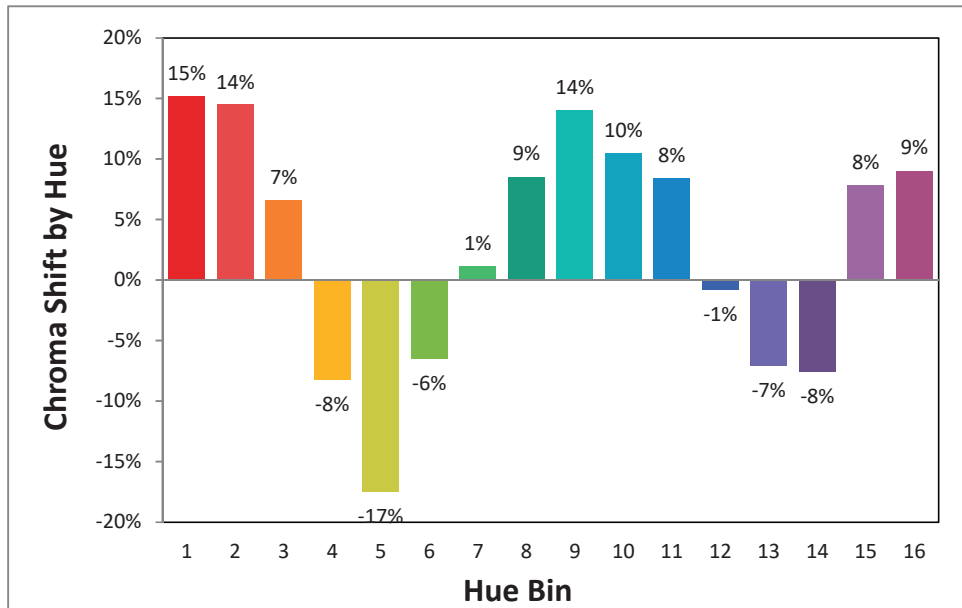

Accessories



MLB-PWR-2P
Power Feed Cable (IP67)
6.5' length
2-PIN M15 Screw Lock Female
connector to Bare Wire



JUMPER-XLR3P-X
Jumper Cable
X = 5, 10, 25 lengths in ft
3-PIN XLR



MLB-JUMPER-M15-4P-X
Jumper Cable (IP67)
X = 10, 25, 100 lengths in ft
4-PIN M15 Screw Lock Female to
Male connector or Hardwire end
for direct connection



DMX3-CAT5-ADPTR
DMX Adapter
3-pin XLR Female to RJ45



MLB-TERM-CAP
End Cap for M15 Female
Connector



MLB-T-CONN-3P
T Connector (IP67)
3-PIN XLR Male for DMX
4-PIN M15 Female for LED
2-PIN M15 Screw Lock Male for Power



ARTNET-S-8-512
8 port universe Artnet to DMX
interface, 4096 DMX channels
(Online or Offline option)

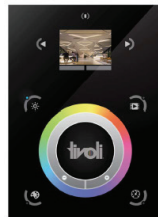

TVOQ-10-XX-7
XX = BK (black), WH (white)
1024 DMX channel, 500 scene,
10 zone, glass touch screen



TVOQ-2-XX
XX = BK (black), WH (white)
512 DMX channel, 99 scene,
1 zone, glass touch screen



ARTNET-L-X-512
X = 8, 16 (ports)
8 or 16 port universe Artnet
to DMX interface,
16 port 8192 DMX channels
8 port 4096 DMX channels
(Online only)



NTG-SWI-8PT
NETGEAR 8-Port Gigabit
Ethernet
Unmanaged Switch



NTG-SWI-16PT
NETGEAR 16-Port Gigabit
Ethernet
Unmanaged Switch



DMX-SPLT-8
DMX Splitter
1 Input to 8 Output
Ethernet or Hardwire Connection

Key & Software Levels

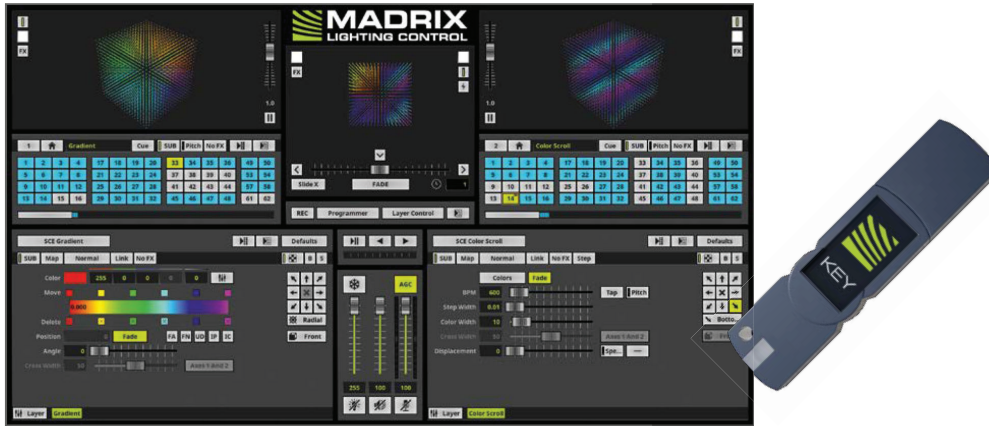

MADRIX KEY

A USB dongle unlocks the software’s full output. You can freely switch between different PCs as it is not bound to a specific one. It only needs to be activated online once.

MADRIX 5 LICENSE UPGRADES

You can easily upgrade your MADRIX 5 KEY to any higher license at any time, increasing the available output.

MADRIX 5 Key & Software Cat No	MDRX-LC-5S	MDRX-LC-5E	MDRX-LC-5B	MDRX-LC-5P	MDRX-LC-5U	MDRX-LC-5M
Level	START	ENTRY	BASIC	PROFESSIONAL	ULTIMATE	MAXIMUM
DMX-Based Output						
DMX Channels	1,024	4,096	16,384	65,536	262,144	1,048,576
DMX Universe Example	2	8	32	128	512	2,048
RGB Voxels Example	341	1,365	5,461	21,845	87,381	349,525
DVI-Based Output						
DVI Voxels	4,096	16,384	262,144	1,048,576	2,097,152	2,097,152
Render Resolution Example	64 X 64 PIXELS	128 X 128 PIXELS	512 X 512 PIXELS	1,024 X 1,024 PIXELS	2,048 X 1,024 PIXELS	2,048 X 1,024 PIXELS

Power Supplies
ADNM - NON DIMMING

DESCRIPTION	CAT NO	APPLICATION	PRIMARY VOLTAGE	SECONDARY VOLTAGE	CIRCUIT BREAKERS	MAX LOAD	CIRCUIT CAPACITY
ADNM Series Class 2 Transformer	ADNM-90-1-4-24-D	Indoor / Outdoor	100-277V AC 5ø60 Hz	24V DC	1	90W	3.75A
	ADNM-120-1-4-24-D				1	96W	4A
	ADNM-240-2-4-24-D				2	2x96W	2x4A
	ADNM-320-3-4-24-D				3	3x96W	3x4A

INFINITY - MLV / ELV / 0-10V / PWM / TRIAC

DESCRIPTION	CAT NO	APPLICATION	PRIMARY VOLTAGE	SECONDARY VOLTAGE	CIRCUIT BREAKERS	MAX LOAD	MIN LOAD	CIRCUIT CAPACITY
Infinity Series Class 2 Transformer	INF-J-30-1-1.3-24	Indoor / Outdoor	100 - 277V AC	24VDC	1	30W	3W	1.3A
	INF-J-60-1-2.5-24				1	60W	6W	2.5A
	INF-J-96-1-4-24				1	96W	9W	4A
	INF-J-192-2-4-24				2	2x96W	2x9W	2x4A
	INF-J-288-3-4-24				3	3x96W	3x9W	3x4A

Wiring Diagram - Offline

ARNET-S

Programmed via MADRIX software and recorded directly to an ARTNET-S interface for media applications and performance. This is a stand-alone feature without a need for network support by software (MADRIX) once recorded to the interface (ARNET-S). Please refer to installation instructions for additional information.

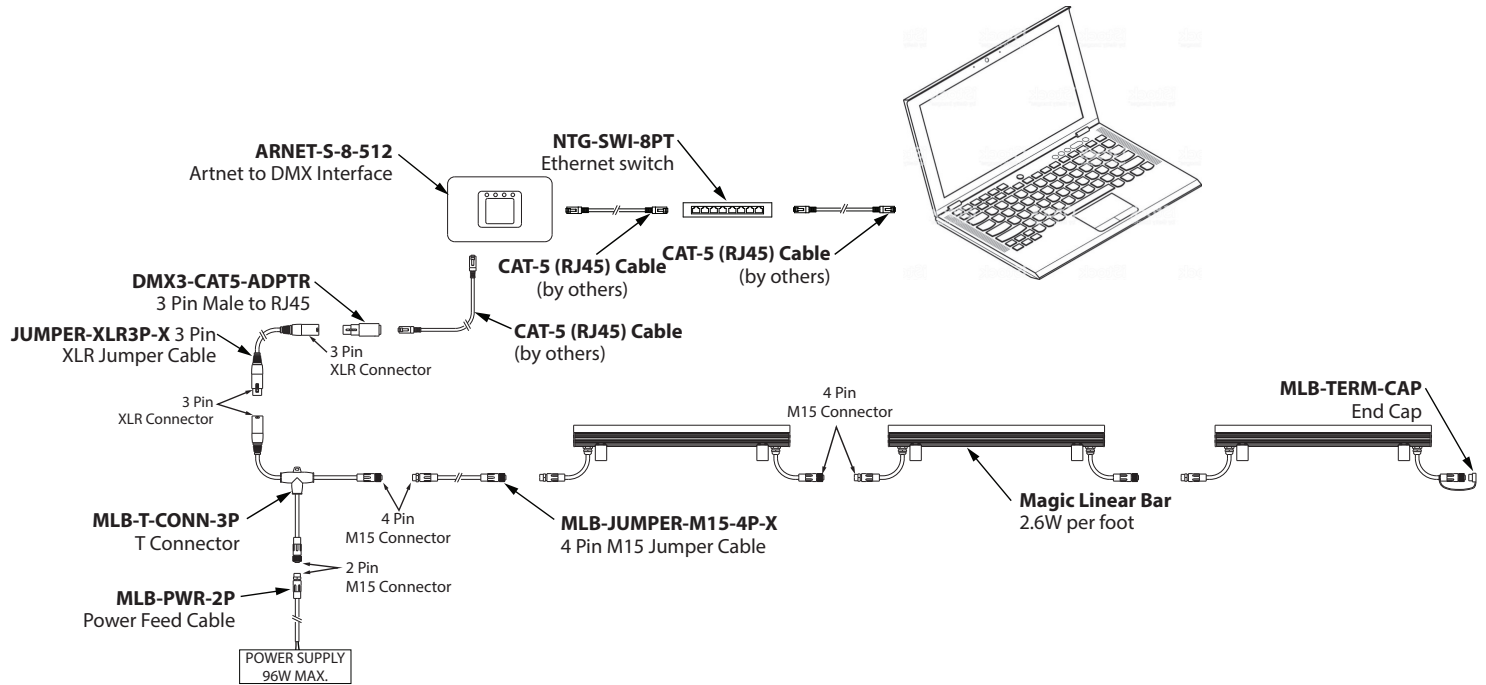

TivoCUE (Preset)

Programmed via CUE software and recorded to a MicroSD card for data transfer into TivoCUE control. This is a stand-alone feature with no need for network support by software (CUE) once recorded and transferred to in-wall DMX control hardware. Please refer to TivoCue 10 User Manual for additional information.

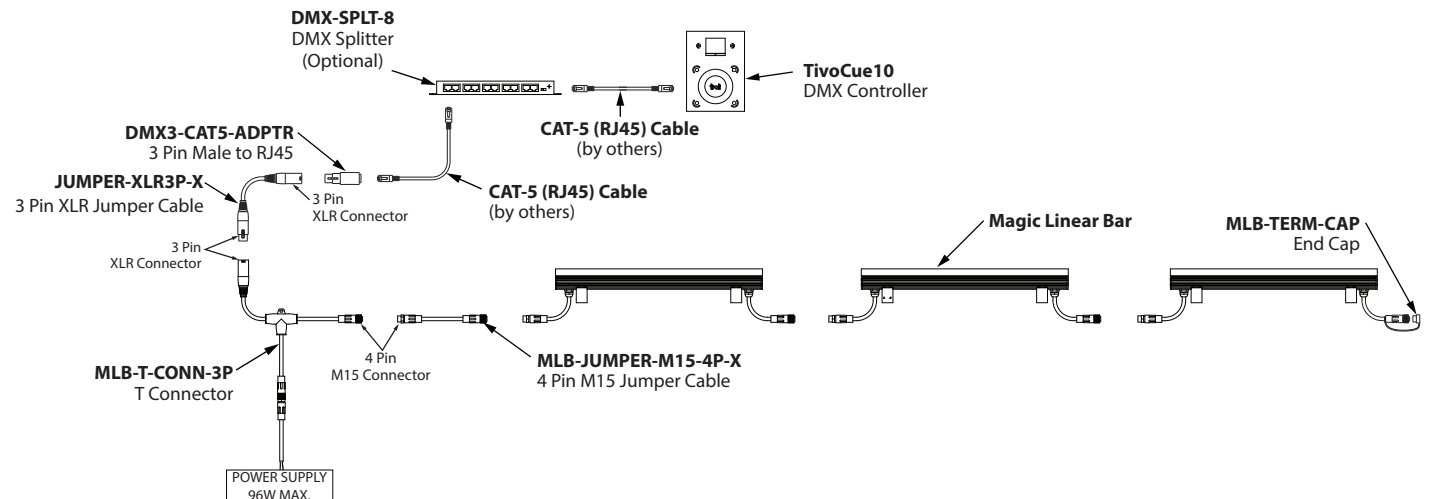

Wiring Diagram - Online

MADRIX Live

This is a live control performance setup, often used for concerts or performance-based manipulation. A live network is necessary for communication between MADRIX software and the fixture. Please refer to installation instructions for additional information.

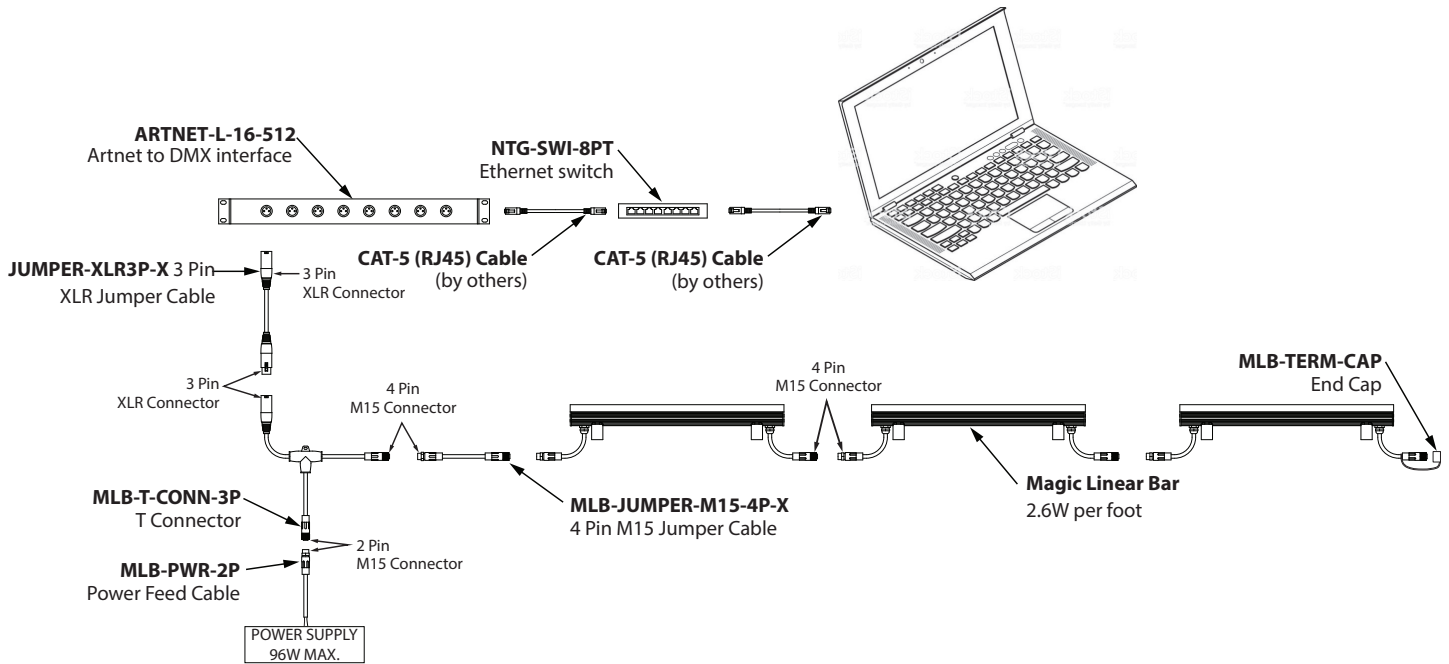

Tivoli Technical Support

DMX projects can be difficult to setup and program when dealing with software and fixtures once you are on site. Tivoli offers technical support from initial contact up to installation and setup if needed. Please contact your local sales rep for pricing and provide details of desired technical support level for your project.



- Phone Support
- Website & Video
- PDF Documents

In-House Customer Support

sales@tivoliusa.com
714-957-6101 (Engineering Tech Support)



- Travel To Site
- Program
- Test & Run System

On-Site Live Support | Commission